



YouSolar.
Power Your Life.
Independently.™



Installation and Operation Manual

STEP™ 380 Micro-Converter

YouSolar, Inc.
292 Brokaw Rd., Santa Clara, CA 95050
United States of America

www.YouSolar.com

Subject to change without notice. YouSolar, PowerBloc, STEP, DIYA, TRAFFIC, CARPTalk, and SPOT are trademarks of YouSolar, Inc. © YouSolar, Inc. 2021 202109

Table of Contents





1.	About this Document	3
2.	Notes, Conventions, Labels	3
3.	Important Safety Instructions	4
4.	Product Listing and Compliance Information	5
5.	The STEP™ Micro-Converter	6
5.1	Product Description	6
5.2	Benefits of STEP	7
6.	Installation	10
6.1	Installation Procedure	10
6.2	Choosing a Location	11
6.3	Attaching STEP to the Racking	11
6.4	Connecting STEP Interconnection Wiring Harnesses	12
6.5	Grounding the System	14
6.6	Creating the Solar Array Map	15
7.	Commissioning	18
8.	During Operation	18
9.	Troubleshooting	19
10.	Disconnecting a STEP from the PV Panel	20
11.	Specifications	22
	Appendix 1	
	1-on-1 Arrangement (Typical)	23
	Appendix 2	
	2-on-1 Arrangement	24

1. About this Document

This document describes the YouSolar STEP™ 380 micro-converter, a solar panel-level direct current-to-direct current (“DC-DC”) converter with Maximum Power Point Tracking (“MPPT”) and power line communication, and provides installation and operating instructions for the STEP 380. It is important to follow the STEP 380’s installation and operating instructions so that the micro-converter performs safely and meets all requirements specified by YouSolar. In the remainder of this manual STEP 380 is referred to as STEP.







2. Notes, Conventions, Labels

To reduce the risk of electrical shock, avoid equipment damage, and guarantee the safe installation and proper operation of the STEP, the following symbols appear in this document.

	This symbol indicates information important for correct system installation and operation. Follow these instructions closely.
	Important! This symbol indicates that the user should take care when performing these tasks. Ignoring precautions could result in unfavorable consequences.
	This symbol indicates a potentially hazardous situation, that, if not avoided, could result in minor or moderate injury, and/or damage to property.
	This symbol indicates a situation where failure to follow instructions may expose the user to electrical or other hazards, or cause serious hardware failure if not applied appropriately. Use caution when performing these tasks.

3. Important Safety Instructions

This manual contains important instructions for the STEP that must be followed during installation and operation of the equipment. **Please save it for future reference.**

	<p>CAUTION</p>	<p>Electrical installations must be carried out in accordance with the National Electrical Code (NEC), ANSI/NFPA 70, and any other codes and regulations applicable to the installation site.</p>
	<p>CAUTION</p>	<p>Only qualified personnel should install and/or replace a STEP.</p>
	<p>CAUTION</p>	<p>Do not attempt to open the STEP. The device contains no user-serviceable parts. In the unlikely event that a STEP should fail, contact YouSolar customer service to obtain a Return Material Authorization ("RMA") before sending the STEP for service.</p>
	<p>IMPORTANT</p>	<p>Tampering with or opening STEP will void the warranty.</p>
	<p>CAUTION</p>	<p>The enclosure of a STEP may reach a temperature of 80°C (176°F) when exposed to the sun in high ambient temperatures. To eliminate the risk of burns, check the temperature of the enclosure before touching it with bare hands or use adequate gloves to protect your hands.</p>
	<p>WARNING</p>	<p>Do NOT disconnect the PV module from a STEP without first turning off all STEPs on a Branch. You can turn off individual Branches on the DIYA user interface or all Branches connected to a STEP™ Solar Input Module by setting the Solar switch to "Disable" on its front panel. NOTE: A Solar Array Branch connects to the PowerBloc's High Potential Direct Current ("HVDC") bus through diodes. Therefore, the HVDC bus cannot energize a Branch. However, for work on the Solar Array other than disconnecting a PV Panel, additional safety precautions must be taken as described in the relevant section.</p>
	<p>WARNING</p>	<p>Never connect two Interconnection Wire Harnesses to create an extension to connect STEPs on a Branch. Doing so will connect the positive side with the negative side of the Branch and create a short.</p>

4. Product Listing and Compliance Information

The STEP micro-converter has been designed and independently tested to meet or exceed the following international requirements and standards:

USA	
UL1741-2005 and IEEE 1547	"Inverters, converters and controllers for use in independent power systems"
FCC Part 15	Limits for a Class B device
CANADA	
CAN/CSA-C22.2 No. 107.1-01	"General Power Supplies"
EUROPE	
This equipment is compliant with the applicable CE Mark Directives:	
- Low Voltage Directive – 2006/95/EC	
- Electromagnetic Compatibility Directive – 2004/108/EC	
- Restriction of Hazardous Substances (RoHS) Directive – 2002/95/EC	
The following standards were used in the evaluation to the above Directives:	
EN60950	"Information Technology Equipment – Safety"
IEC 61000-6-1-2005	"Electromagnetic compatibility generic standards – immunity for residential, commercial and light-industrial environments"
IEC 61000-6-3-2006	"Electromagnetic compatibility generic standards – emission standard for residential, commercial and light-industrial environments"

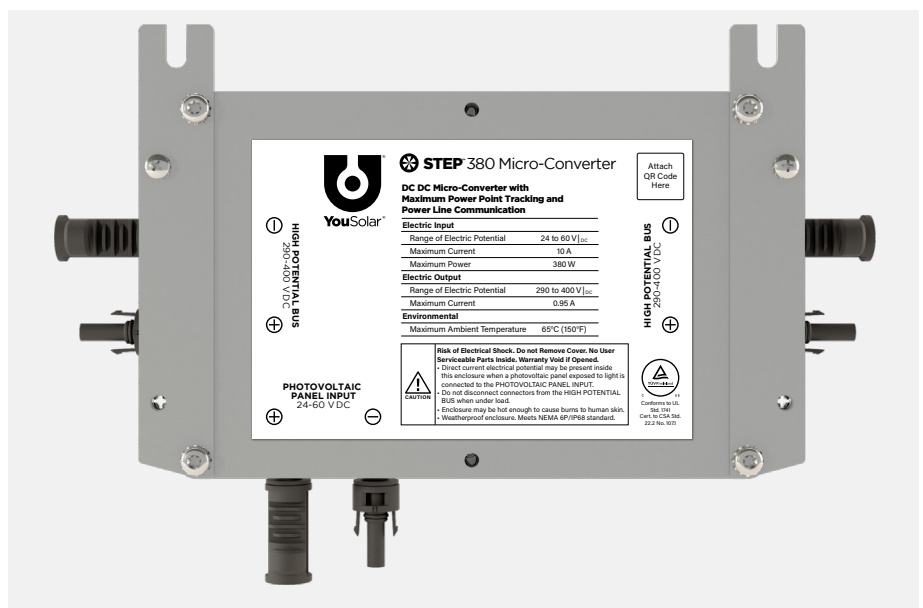

5. The STEP™ Micro-Converter

5.1 Product Description

The STEP from YouSolar represents the next stage of maximum energy harvesting from photovoltaic ("PV") solar arrays. STEP performs a unique power conversion that allows parallel connection of any photovoltaic panel ("PV panel") with an open circuit potential between 24 Volt and 60 Volt to the High Potential Direct Current ("HVDC") bus of the PowerBloc® nano-grid. By connecting solar panels in parallel using STEPs, each solar panel becomes an independent power source whose energy production is maximized through panel-level Maximum Power Point Tracking ("MPPT") whether the panel is under full sun or cloudy conditions. This allows the inverter to run at the constant potential of the HVDC bus (versus in MPPT mode for string inverters) which allows the inverter to run at its peak efficiency. STEPs mount to the PV racking, and connect to each other with Interconnection Wire Harnesses. A series of interconnected STEPs forms a "Branch" of the Solar Array. A Solar Array may include one or more Branches. Each Branch transmits CARPTalk™ communication over the power line to all STEPs on the Branch.

PANEL POWER MAXIMIZATION

Panel-level Maximum Power Point Tracking ("MPPT") ensures that each panel operates at maximum power output regardless of how other panels in the Solar Array perform. A shaded or underperforming panel will only affect the output of the STEP that it is connected to. The STEP MPPT is a real-time, instantaneous correction function with better than 99.7% tracking.

MIXING DIFFERENT PV PANELS

The normalization of the output potential of all PV panels to the HVDC bus potential allow unprecedented ability to mix PV panels of different technology or size. Various PV panels, including building-integrated photovoltaic, thin-film, or crystalline panels can be used on the same Branch of the Solar Array. PV Panel mismatch, either initial or caused by age-related degradation, has no effect on the Solar Array's energy production. To create a Solar Array simply plug PV panels into the STEPs and then chain up to thirty (30) STEPs together using the Interconnection Wire Harnesses provided by YouSolar.

EASY EXPANSION

The parallel architecture allows easy Solar Array expansion with up to thirty (30) STEPs on a Branch. The STEP™ Solar Input module of the PowerBloc® supports up to two (2) Branches. Additional, STEP™ Solar Input Modules allow for a larger Solar Array. The PowerBloc supports up to five (5) Branches with a total of 57 kW of solar power (DC power at Standard Test Conditions (STC)). Additional PV panels including PV panels of different make and chemistry can be added to an

existing Branch provided it has less than 30 STEP micro-converters on it. A retrofit to an existing installation is quick and simple.

PANEL IDENTIFICATION, MONITORING AND REPORTING

Each PV panel is identified through the STEP (which has a serial number) to which it is connected. The PowerBloc’s controller, TRAFFIC™, continuously monitors the PV panel for performance and creates diagnostic alerts such as cleaning recommendations for soiled panels. The TRAFFIC controller can individually or collectively turn off PV panels in an emergency or ahead of a service. Each STEP sends data to TRAFFIC over the Interconnection Wire Harnesses and Home Run Cable using YouSolar’s CARPTalk™ power line communication. Monitoring of Solar Array production in combination with YouSolar’s real-time, location-specific and hourly Solar Irradiance Data Service, SPOT™, can be used to assess PV panel performance, such as degradation, failure, and soiling of solar panels.

5.2 Benefits of STEP

SAFETY

STEP incorporates advanced features to enhance safety during installation and operation. Importantly, STEP does not produce an electric potential on its High Potential Bus connectors unless the STEP is connected to a Solar Array Branch and has received a turn-on/stay-on signal over CARPTalk™ powerline communication from the TRAFFIC™ controller. STEP requires a periodic heartbeat of the turn-on/stay-on signal from TRAFFIC to stay on.

CAUTION	<p>Except in an emergency, do not disconnect a Branch from the PowerBloc®’s HVDC bus by opening (i) the Solar Array DC Disconnect on the back panel of the STEP™ Solar Input module and/or (ii) an external Solar Array Disconnect before turning off all STEPs on a Branch. Doing so may cause arcing across the Solar Array DC Disconnect when opened.</p>
----------------	--

During installation, a STEP does not produce an electric potential on its High Potential Bus connectors, and thus installers do not encounter the high open-circuit potentials of string arrays.

Ahead of a service of a Branch of Solar Array, all STEPs in that Branch must be turned off. You can turn off an individual Branches on the DIYA user interface or all Branches connected to a STEP™ Solar Input Module by setting the Solar switch to “Disable” on its front panel. When a Branch is turned off on DIYA or on the front panel of the STEP Solar Input Module, the Branches’ electric potential

will reduce to 30 V in 16 seconds. A Solar Array Branch connects to the PowerBloc's High Potential Direct Current ("HVDC") bus through diodes. Therefore, the HVDC bus cannot energize a Branch. However, for work on the Solar Array, after turning off the Branch(es) open (i) the Solar Array DC Disconnect on the back panel of the STEP™ Solar Input module and/or (ii) an external Solar Array Disconnect. The Solar Array DC Disconnect on the back panel of the STEP™ Solar Input module contains fuses. We recommend removing the fuses during the service for absolute safety. NOTE: There is no need to power down the HVDC bus to service the Solar Array.

How to turn off all STEPs on a Branch and isolate the Branch from the PowerBloc's High Potential Direct Current (HVDC) Bus:

Turning off a Branch

- 1.** Go to the Solar Array screen on the DIYA User Interface. Identify the Branch you want to power down and slide down the Array Power Button.

OR

- 2.** Move the Solar switch on the front panel of the STEP™ Solar Input Module to "Disable." This will turn off all Branches connected to the module.

Isolating a Branch for the HVDC Bus (After Turning off all STEPs on the Branch)

- 1.** Open the Solar Array DC Disconnect on the back panel of the STEP™ Solar Input module. (The Solar Array DC Disconnect on the back panel of the STEP™ Solar Input module contains fuses. We recommend removing the fuses during the service for absolute safety.)

OR

- 2.** Open the external Solar Array Disconnect, which is typically required by local electrical code.

In an Emergency

- 1.** Press the External Emergency Stop Button.

OR

- 2.** Press the Emergency Stop Button on the front panel of the TRAFFIC Controller.

OR

- 3.** Slide down the Emergency Stop Button on the DIYA™ User Interface.

Any of these three actions will turn off the Branch, except that pressing the Emergency Stop Button will also power down the HVDC bus and result in a loss of power from the PowerBloc®.

A STEP that is disconnected from the HVDC bus and, therefore, receives no signal from the Solar Controller and, therefore, has no electric potential on its High Potential Bus connectors even if a PV panel is connected to the STEP.

Each STEP has an internal current limiter (set at maximum current of 0.95 A) on the output of the micro-converter power circuit that connects to the HVDC bus wires inside the STEP's enclosure. This current limiter provides faster overcurrent mitigation than standard fuses. Each STEP also has diode protection on its output, which protects the STEP and the PV module from potentially harmful reverse currents in the event of a PV module failure.

RELIABILITY

Each STEP converter is also fused, which eliminates the need for a PV panel series/string fuses at a junction box, although such fuses may still be required by local code.

String inverters can sustain damage if they are exposed to excessive input potentials. These high electric potentials can occur when panel temperatures decrease causing the panels' open-circuit potentials to increase. In contrast STEP maintains its output potential below 400 VDC, and thereby, the electric potential of the Branch regardless of the number of panels on the Branch or the ambient temperature.

The STEP housing is watertight and complies with the NEMA 4 / IP 66 environmental enclosure rating standards and is designed to operate at full power at ambient temperatures of up to 65°C (149°F).

PARALLEL SYSTEMS



Parallel-connected PV systems, such as the parallel Solar Array created by STEPs, are inherently more reliable than serially connected systems. A parallel system ensures that, if a PV panel fails or is shaded it does not reduce or eliminate power from the entire Branch as it would in a string array.

PV panel arrays using STEPs are simple to design and install. Because multiple Branches of the Solar Array are connected in parallel, string potential calculations are not required. Individual PV panels can also be installed in any combination with other PV panels of different type, size, age, or orientation.

COST SAVINGS

The use of a parallel architecture reduces the amount and complexity of cabling and components needed for installation. The use of STEP micro-converters eliminates the need for multiple strings running to combiner boxes as which is typically required for solar arrays that connect PV Panels in series as a string.

6. Installation

	IMPORTANT	Before installing a STEP read all instructions and cautionary markings on the STEP and this Installation and Operation Manual available on the YouSolar DIYA™ User Interface, on YouSolar’s website, or by contacting YouSolar.
	CAUTION	Perform all electrical installations in accordance with all local electrical codes and the National Electrical Code (NEC), ANSI/NFPA.

STEP quickly mounts on the PV racking that holds the PV panel. The STEP is secured by using either 3/8", 1/4", 10-mm, or 6-mm bolts through the slots and holes of STEP’s mounting bracket. This hardware should be stainless steel as used elsewhere in the assembly of the installation.

The STEP can be attached in any orientation that suits the installation. The Interconnection Wire Harness is designed to connect adjacent STEPs. Aligning STEPs in the same orientation along the array makes wiring easy and secure.

The enclosure of the STEP can be electrically bonded to the panel mounting structure by using approved bonding devices such as the Wiley WEEB 9.5NL grounding washer between the bracket and the mounting rack. These grounding washers can be obtained from a solar equipment supplier.

6.1 Installation Procedure

Installing a STEP Solar Array involves six key steps:

-
- 1. Choosing the locations of the STEPs on the racking**
See Section "6.2 Choosing a Location"

 - 2. Attaching the STEPs to the racking**
See Section "6.3 Attaching the STEPs to the Racking"

 - 3. Connecting the STEP Interconnection Wire Harnesses**
See Section "6.4 Connecting the STEP Interconnection Wire Harnesses"

 - 4. Grounding the system, if necessary**
See Section "6.5 Grounding the System"

 - 5. Creating the Solar Array layout map**
See Section "6.6 Creating the Solar Array Map"

6.2 Choosing a Location

A STEP can be mounted to many types of PV panel array racking. Choose a location for STEP on the rack that allows for the convenient connection of the PV panel cables (a.k.a. “pigtailed”) to the STEP and of the Interconnection Wire Harnesses between STEPs. Allow adequate slack in the Interconnection Wire Harnesses for cable tension relief. STEP should be mounted behind the PV panel where it is protected from direct sunlight. Mounting the STEP behind the PV panel also helps to ensure that STEPs and wiring do not obstruct sunlight, do not pose trip hazards for personnel servicing the Solar Array, and are protected from damage.

6.3 Attaching STEP to the Racking

It is generally easier to attach the STEPs before securing the PV panels because this method improves access to install the fastening hardware and make minor adjustments. The STEP can be mounted in a wide variety of orientations, depending on the type of racking and available space. Confirm that the wiring easily reaches between the PV panel and STEP and between STEPs. When the STEP is correctly positioned, fasten the hardware.

The drawing of the exterior design of STEP which shows its attachment point.

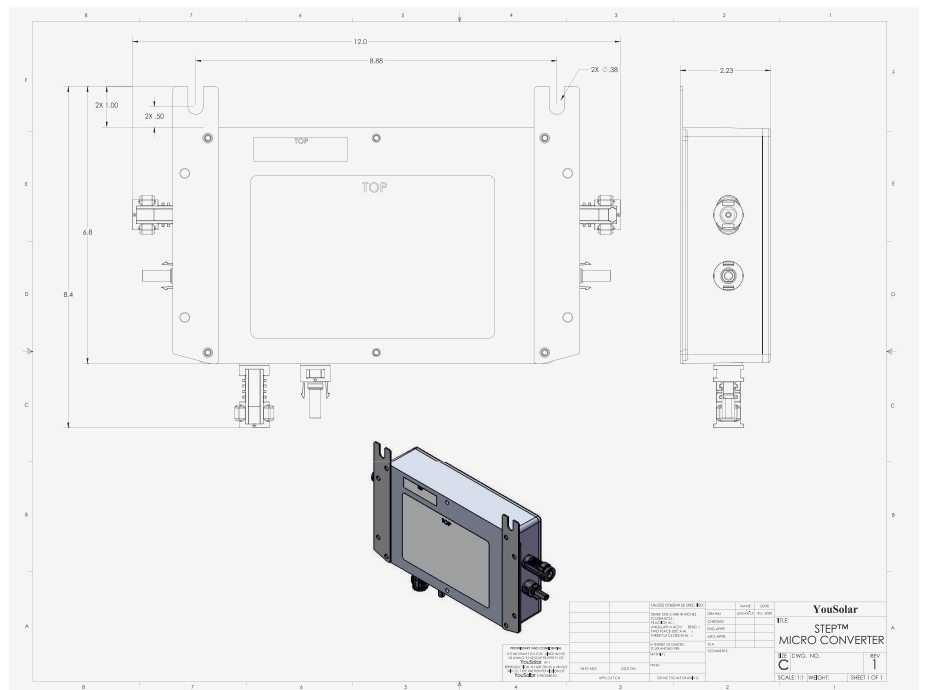

	<p>Prior to securing PV panels which typically leaves a STEP inaccessible behind the panel, it is advised to record the STEP's serial number, its position on the Branch, and its location on the array. Please also see the section "Creating the Solar Array Map" for instructions on how to build a spatial map of the Solar Array using the DIYA[™] tablet.</p>
	<p>Ensure that the STEP does not touch the rear surface of the PV panel. Direct contact of STEP with the PV panel can lead to heat buildup that can damage the PV panel.</p>

6.4 Connecting STEP Interconnection Wiring Harnesses

Most PV panels are terminated with a pair of single-pole Multi-Contact type connectors ("MC4"). The STEP micro-converter uses connectors that are compatible with MC4 and most equivalent connectors. Where PV panel connectors differ, adapters have to be made by the installer. Certain adapters are also available from YouSolar for purchase.

Each STEP also has two pairs of connectors to the HVDC bus on opposite sides of the STEP enclosure, the High Potential Bus connectors. The High Potential Bus connectors on each side of the enclosure are directly connected inside the STEP and are electrically at the same point. The Interconnection Wire Harnesses link the HVDC bus on one STEP to that of another. The Interconnection Wire Harness is keyed and color coded to prevent installation errors.

Interconnection Wire Harness.

The negative side of the High Potential Direct Current ("HVDC") Branch uses a cable with black insulation. The cable is terminated by two female MC4-compatible connectors that only fit the male connectors of the negative HVDC inputs of the STEP. The positive side of the HVDC Branch uses a cable with red insulation. The cable is terminated by two male MC4-compatible connectors that only fit the female connectors of the positive HVDC inputs of the STEP. This color-scheme and keying of connectors eliminates any inter-connection mistakes between STEPs. The cables are colored to prevent someone from connecting two Interconnection Wire Harnesses to create an extension. Such an extension would create a short between the positive and negative sides of the HVDC Branch.

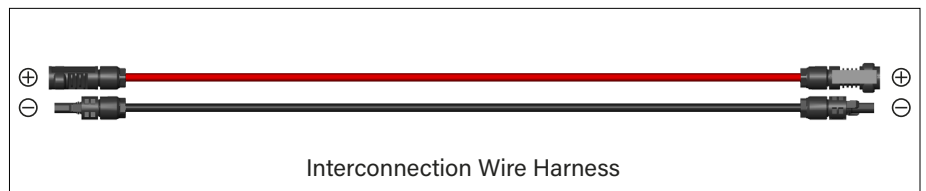

The position of the two pairs of bus connectors on the STEP enclosure are oriented so that multiple STEPs can be connected in a line to form a continuous HVDC Branch. In the unlikely event that one STEP becomes inoperable the HVDC "passing through" the inoperable STEP creates continuity of the HVDC bus and the contributions of the operating STEPs are unaffected.

MC4 Connectors

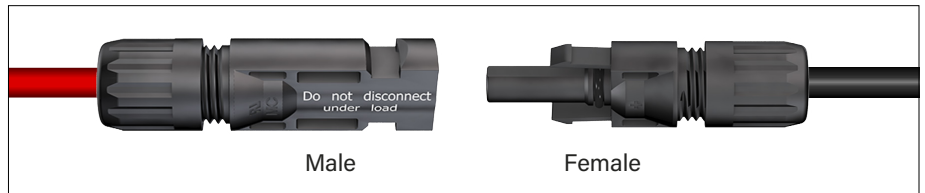

The correct MC4 connector “gender” is based on the shape of the conductor inside the connector and not the appearance of the plastic body of the connector. A MC4 connector that appears to be “male” is actually “female” and vice versa.

The order of connection is as follows:

1. Plug in and secure the Interconnection Wire Harness between the High Potential Bus connectors adjacent STEPs to form a continuous Branch circuit.

2. Connect the PV panel wires to the Photovoltaic Panel Input on the STEP's enclosure. Please note the connector's polarity. Polarity of the connectors matches the de facto industry standard for connectors on the PV panel “pigtailed.” However, please confirm the polarity of the PV panels wires before plugging the wires into the Photovoltaic Panel Input.

3. Connect the last STEP on either side of the Branch to the “Home Run” cable leading to the a solar input port on the STEP™ Solar Input Module. YouSolar can include the Home Run cable if requested by the customer, but cabling from the roof to the Solar Controller is typically supplied by the solar installer. The STEP™ Solar Input Module has a fused DC Solar Array Disconnect to isolate all Branches from the HVDC bus. In addition, all Branches are connected to the HVDC bus inside the STEP™ Solar Input Module with diodes. Therefore, the HVDC bus cannot energize the Branch.
 However, if code requires that the Home Run cable terminates in a junction box with an External DC Solar Array Disconnect, then care must be taken that multiple Branches do not connect to a common bus bar inside the DC Solar Disconnect that share a common bus bar because this would mix signals from the CARPTalk™ power line communication.
 In either case, whether connected directly to the STEP Solar Input Module or first connected to a junction box, all connections must be made in accordance with local codes, the National Electrical Code (NEC), and ANSI/NFPA70.

4. The STEP at the end of the Branch not connected to the Home Run cable has an unused pair of High Potential Bus connectors. This “open” pair must be plugged with termination plugs to prevent water from entering the STEP though the open connectors. YouSolar provides termination plugs for each Branch on the STEP Solar Input Module. If the termination plugs provided by YouSolar and are lost during installation or at any later point, then these plug are generally available from solar equipment suppliers or from YouSolar.

	WARNING	<p>The Interconnection Wire Harness and the Home Run cable have the American Wire Gauge of 10 ("AWG 10") and the current rating of the MC4-compatible connector on the STEP enclosure limit the maximum current on the Branch to 30 A. Each STEP has current limit of 0.95 A. Attenuation of the CARPTalk™ signal on the Branch cable further limits the number of STEPs in a Branch. Both constraints limit the number of STEPs to thirty (30) per Branch.</p> <p>During commissioning and periodically, the Solar Controller will query a Branch for the number of STEPs connected on the Branch. The Solar Controller will not turn on the STEPs on a Branch if the number of STEPs or the maximum current are exceeded. The Solar Controller also continuously measures the current of each Branch. If the Branch current exceeds 30 A, the Solar Controller will reduce ("throttle back") the output current of all STEPs on the Branch until it falls below 30 A.</p> <p>Refer to the National Electrical Code (NEC) 70, Article 310 for details on general wiring requirements.</p>
---	----------------	--

6.5 Grounding the System

If equipotential bonding is required, it can be achieved by using suitable ground circuit washers approved for the solar array racking when mounting the unit such as Wiley WEEB 9.5NL. Alternatively, a PV grounding lug can be attached to the stud provided on the STEP enclosure and used to bond the STEP to the frame using bare copper grounding conductors. Please refer to NFPA 70, Art 690, and ensure compliance with all local codes.

6.6 Creating the Solar Array Map

The YouSolar monitoring system allows you to track the performance of individual STEP modules and the panel attached to it. To identify a STEP-PV panel pair a spatial map of the Solar Array and the position of the STEP-PV panel pair on the Branch is required. Such a map of the Solar Array and Branch must be created during installation.

The DIYA™ User Interface, which runs on an Android tablet, is used to create this map. Using DIYA makes creating a Solar Array map easy and efficient. The Solar Array screen of the user interface is a grid centered on the location of the array as determined by the tablet's Global Positioning System. During installation the STEP-PV panel pairs are added one by one to the grid on the Solar Array screen and placed in position using hand gestures. During the creation of the Solar Array layout, a STEP-PV panel icon can be selected, and the tablet's camera is used to scan the QR code on the corresponding STEP. Other information such as the PV panel specifications and orientation (azimuth and elevation) are entered as well. Finally, hand gestures allow the installer to draw the connection from STEP to STEP on the Branch and the Home Run cable towards the STEP™ Solar Input Module. The Solar Array screen allows for the easy and efficient creation of a spatial map, but equally important, the data of the STEP-PV panel pairs and the layout are transferred to the TRAFFIC Controller's Registry of all components on the system. This Registry is used for inventory, warranty management, and by the PowerBloc®'s Energy Management System, EDISON™.

Alternatively, as a backup, or reference for the installer, the Solar Array layout can be related to a grid in a spreadsheet as shown below. The Solar Array is represented by a series of rows and columns that can be used to provide a physical reference to your site as shown in the exhibits of this section.

Example of defining columns and rows on a Solar Array

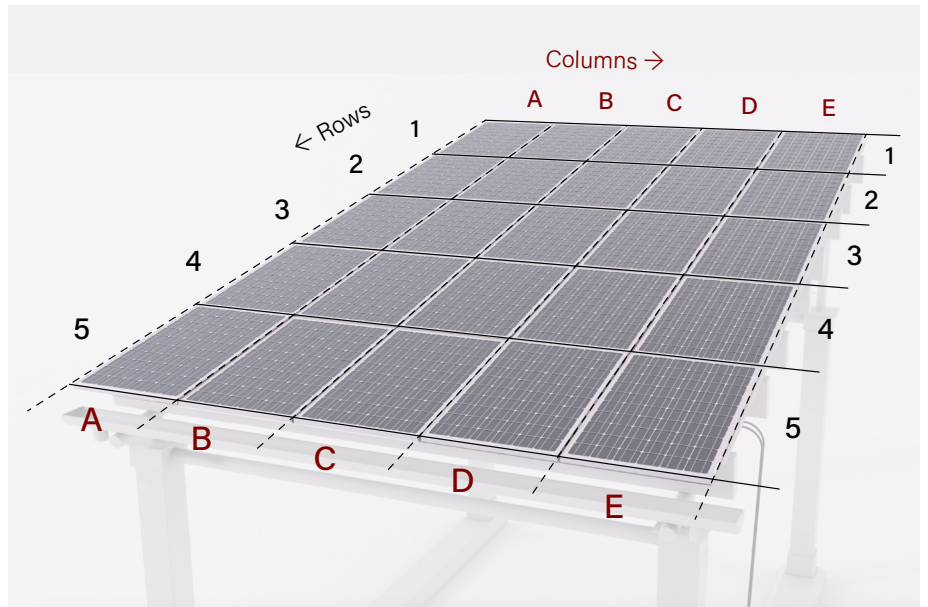

Using a spreadsheet to keep track of the serial numbers of each STEP in the array

Date:
Location:
Array No.:

		Columns →							
		A	B	C	D	E	F	G	H
← Rows	1								
	2								
	3								
	4								
	5								
	6								
	7								
	8								
	9								
	10								

Procedure:

- 1.** Turn on the DIYA™ tablet User Interface and navigate to the Solar Array screen, which will show a grid. The tablet's Global Positioning System will center the grid at the current location. Move to a location on the physical solar array which is a convenient point of reference and lock the location of the center point. Use the screen menu to position the STEP-PV panel pairs on the grid, enter the STEP-PV panel data, and draw the connections between STEPs on the Branch. The Solar Array screen supports multiple Branches.
- 2.** Each STEP has a QR code located on its top cover. Select the icon representing the STEP on the Solar Array screen of DIYA and scan the QR code using the tablet's camera. The STEP's serial number and specifications will be linked to the STEP on the array layout. The Solar Array data will upload to the nano-grid's Controller, TRAFFIC™, and YouSolar's service and warranty department.
- 3.** At any time, but typically concurrent with the scanning of the STEP's QR code, the PV panel data is entered. To do so, select the panel icon and enter the key specifications of the panel as well as its orientation (azimuth and elevation). For tablets equipped with an inclinometer and/or compass the tablet can be used to determine the PV panel's orientation. For subsequent panels the information is auto-filled but can be changed if panels on the Branch have different specifications or orientations. The panel data will upload to the system's controller, TRAFFIC, and YouSolar's service and warranty department.
- 4.** Upon completion of the array layout the Solar Array screen prompts the user to take photos of the array(s). The photos are saved to the TRAFFIC Controller and upload to the YouSolar service and warranty department.
- 5.** During operation of the system, the customers can monitor the PV panel performance on the DIYA User Interface or via the Internet on the YouSolar app or customer web portal. PV panels which show performance deviations would be highlighted on the Solar Array screen.

7. Commissioning

Commissioning the STEP Solar Array is automatic because the Solar Array screen of the DIYA™ User Interface transfers the data to the TRAFFIC™ Controller's component Registry, which is used by TRAFFIC for performance monitoring and by the EDISON™ energy management system for forecasting solar production. TRAFFIC will compare the serial number of the STEPs entered into its Registry with those of the STEPs on the Branch when performing a Registry Check during start-up (and periodically during operation). If there are discrepancies between the Registry and the STEPs detected on the Branch, DIYA will prompt the user to make corrections. Provided that there are no more than 30 STEPs on a Branch the TRAFFIC Controller will turn on and use the Branch irrespective of any Registry discrepancies. The controller will even turn on the Solar Array if the Solar Array map has not been completed.

8. During Operation

Data from all STEPs are available on the DIYA™ User Interface, the YouSolar app or on the YouSolar customer web portal. The solar production data is also stored in a log file in the local memory of the TRAFFIC™ Controller. For Internet-connected systems and provided the customer has given permission, the solar data will also be accessible remotely by YouSolar for monitoring and troubleshooting, and stored on YouSolar's cloud server.

9. Troubleshooting

If the STEP branch does not deliver power to system please check the following:

- 1.** Verify that the STEP modules are properly connected to each other, starting with the STEP that is furthest from the STEP connected to the Home Run cable.

- 2.a** Verify that the fused DC Solar Array Disconnect on the Solar Input module is in the “on” position.

- 2.b** If local code requires that Solar Array Branches must first connect to an external junction box equipped with DC Solar Array Disconnects confirm that all Disconnects are “on” and that the Disconnects are NOT on a common bus bar. Having multiple Branches connecting on a common bus bar does not create an electrical hazard but it will result in cross-talk of Branch-specific CARPTalk™ communication lines. This cross-talk will cause communications problems that will result in none of the STEP turning on or unpredictable operation of the STEPs.





- 3.** The Home Run cable is not connected to the Solar Input port of the STEP Solar Input Module or the MC4 connectors on the Home Run cables are, thus, not properly made and are open or arcing.

- 4.** The arc fault detector has detected possible arcing in the Branch. The DIYA™ User Interface will show an alert and the Arc Fault Indicator Light on the TRAF-FIC™ Controller Module will turn on.

- 5.** The HVDC bus has not been turned on and consequently the CarpTalk™ power line communication has not sent a turn/stay-on signal to the STEPs.

If the STEP micro-converters are still not producing power, use a DC potential probe (of a “multi-meter”) and check that the PV panel(s) connected to the STEP unit(s) have an electric potential of greater than 24V but no more than 60V when exposed to sunlight.

If after completing these steps the STEP still is not producing power, please see our website at www.YouSolar.com for further troubleshooting tips or contact YouSolar customer support. You can reach customer support at the number provided on our website or by pressing the Contact YouSolar button on the DIYA™ User Interface.

		Do not attempt to repair a STEP micro-converter because it contains no user-serviceable parts. If troubleshooting methods fail, the STEP must be returned to YouSolar or authorized partners.
		Only qualified personnel should troubleshoot the Solar Array and STEP.

10. Disconnecting a STEP from the PV Panel

Before disconnecting any STEP, all STEPs on a Branch must be turned off. You can turn off individual Branches on the DIYA user interface or all Branches connected to a STEP™ Solar Input Module by setting the Solar switch to "Disable" on its front panel. A Solar Array Branch connects to the PowerBloc's High Potential Direct Current ("HVDC") bus through diodes. Therefore, the HVDC bus cannot energize a Branch. However, for work on the Solar Array, after turning off the Branch(es) open (i) the Solar Array DC Disconnect on the back panel of the STEP™ Solar Input module and/or (ii) an external Solar Array Disconnect. The Solar Array DC Disconnect on the back panel of the STEP™ Solar Input module contains fuses. We recommend removing the fuses during the service for absolute safety.

Alternatively, you can turn off the all STEPs on a branch by powering the HVDC bus. The HVDC bus can be powered down on the DIYA™ tablet's Control screen, by pressing the Emergency Stop on the TRAFFIC™ controller module or the External Emergency Stop button mounted in the proximity of the PowerBloc. Then the Solar DC Disconnect on the Solar Input module should be switched to "OFF" to prevent the Solar Array from being energized by the nano-grid. Powering down the HVDC bus will result in loss of power to the inverter or to any DC loads that are directly connected to the HVDC bus such as LED lighting.

NOTE: There is no need to power down the HVDC to service the Solar Array.

If a STEP is defective and a replacement is not immediately available and if faulty connectors on the STEP enclosure or an open line of the HVDC bus inside the STEP enclosure are not the problem, then the defective STEP can be left in place until a replacement is available. The PV panel should be disconnected from defective STEP. If the STEP interrupts the HVDC bus, the STEP enclosure is damaged, water intrusion is possible, or a major circuit failure of the STEP electronics is suspected, then the STEP must be bypassed. To do so, install a pair of male-male and female-female MC4 jumper cables across the STEP and connect to the Interconnection Wire Harness of the adjacent STEP(s).

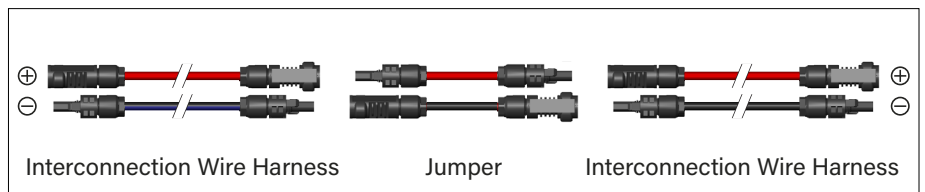

	<div style="border: 1px solid black; padding: 2px; display: inline-block; font-weight: bold; font-size: 0.8em;">WARNING</div>	<p>Typically, there is enough slack in the Interconnection Wire Harness on either side of the a STEP and you may be tempted to bypass the STEP by simply connecting these two wire harness without the aforementioned male-male and female-female jumper pair. However, doing so will connect the positive side to the negative side of the bus and create a short.</p>
--	---	---

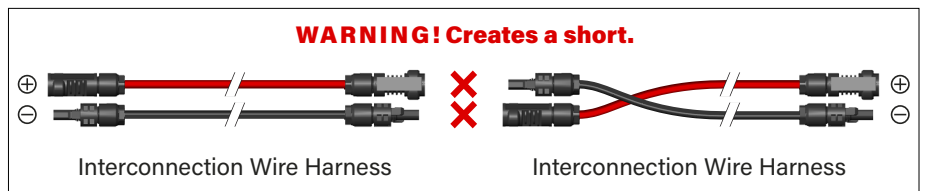

11. Specifications

Technical Specifications STEP™

Input	
Power min./max.	0 / 380 W (self-limited)
Potential min./max.	24 / 60 V _{DC} (self-limited)
Current min./max.	0 / 10 A _{DC} (self-limited)
Output	
Power min./max.	0 / 380 W
Potential min./max.	320 / 400 V _{DC}
Current min./max.	0 / 0.95 A _{DC}
Efficiency	97-98 %
Max. Through Current	30 A
Max. STEP on Parallel Branch	30
MPPT	
Efficiency	99.7 %
Operating conditions	
Ambient Temperature	- 40 °C (-40 °F) to + 65 °C (150 °F)
Night Power Consumption	0 W
Output Fuse Rating	Not Fused
Over Potential Protection	420 V
Enclosure	
Environmental Protection	IP66 / NEMA 4
Manufacturer of MC4-compatible Connector	TE Connectivity
Dimensions (excluding mounting bracket)	180 × 163 × 44 mm
Weight	1.1 kg (2.5 lbs)

For more information, refer to the YouSolar website:

www.YouSolar.com

Appendix 1
1-on-1 Arrangement (Typical)

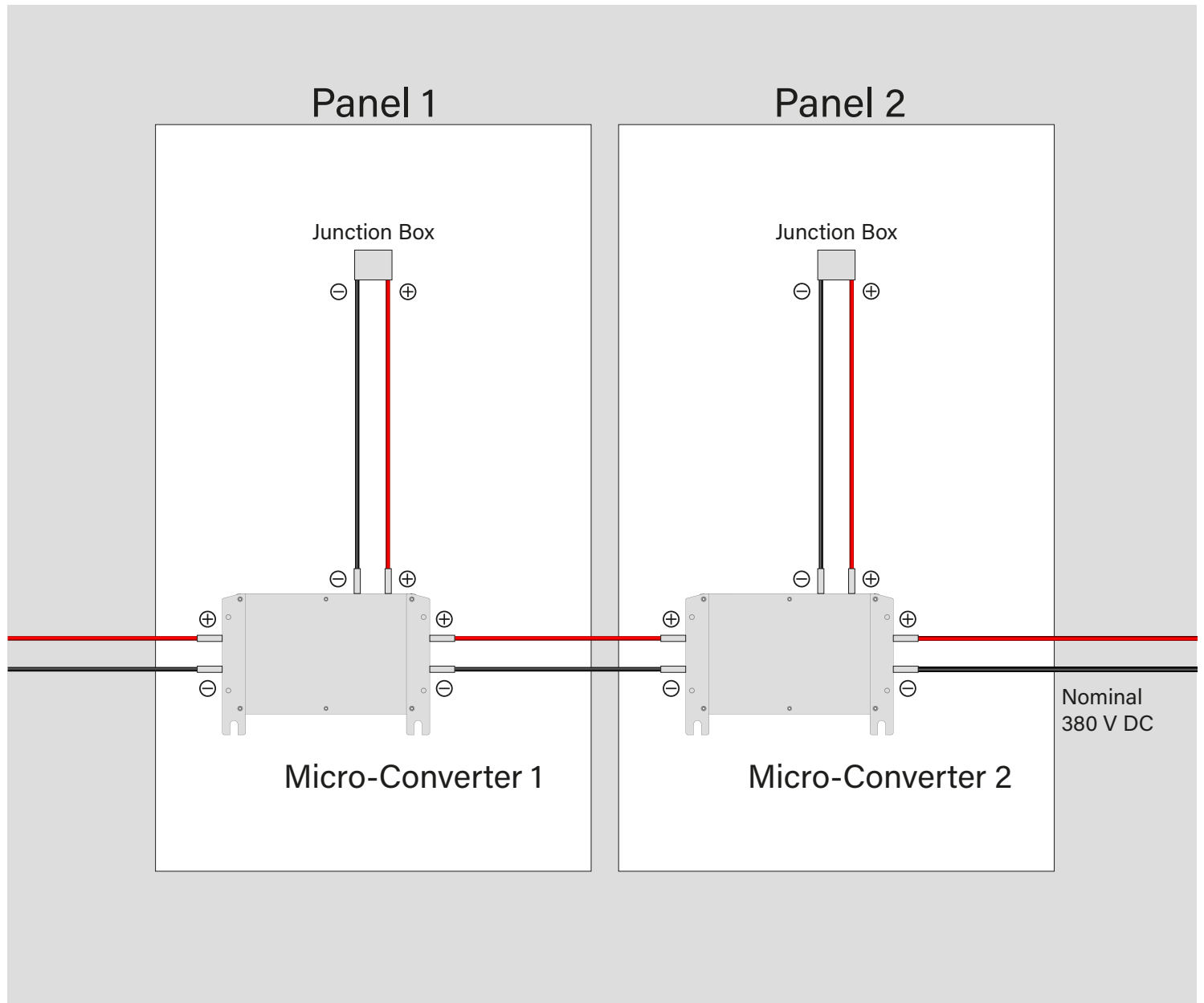

Appendix 2
2-on-1 Arrangement

